



**AGR Subsea Inc.**

September 9-11, 2010

# What is Riserless Mud Recovery (RMR®)

- Return of drilling fluid to drill ship from mud line in “Top-hole” drilling
- Subsea pumps provide lift
- Permits use of improved mud
- Developed for “Top-hole” drilling

# RMR<sup>®</sup> vs. Conventional Drilling

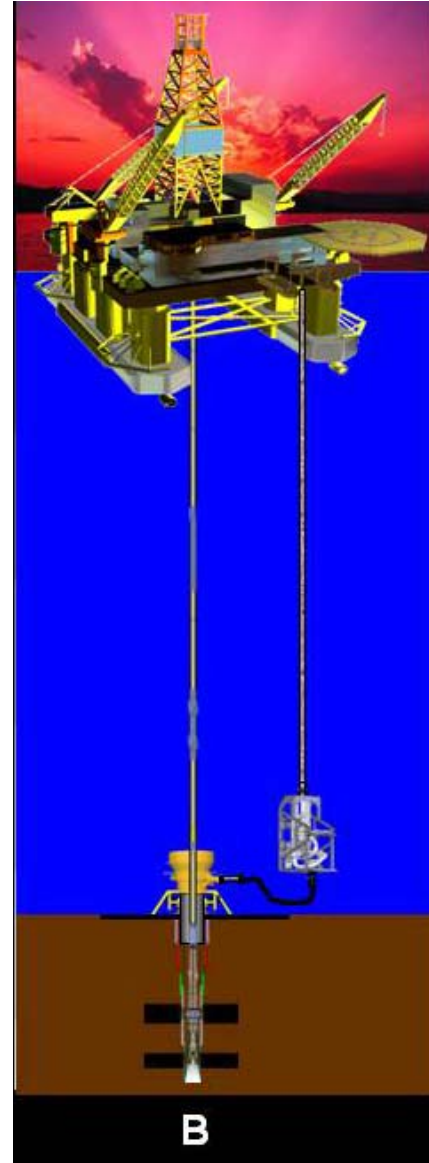
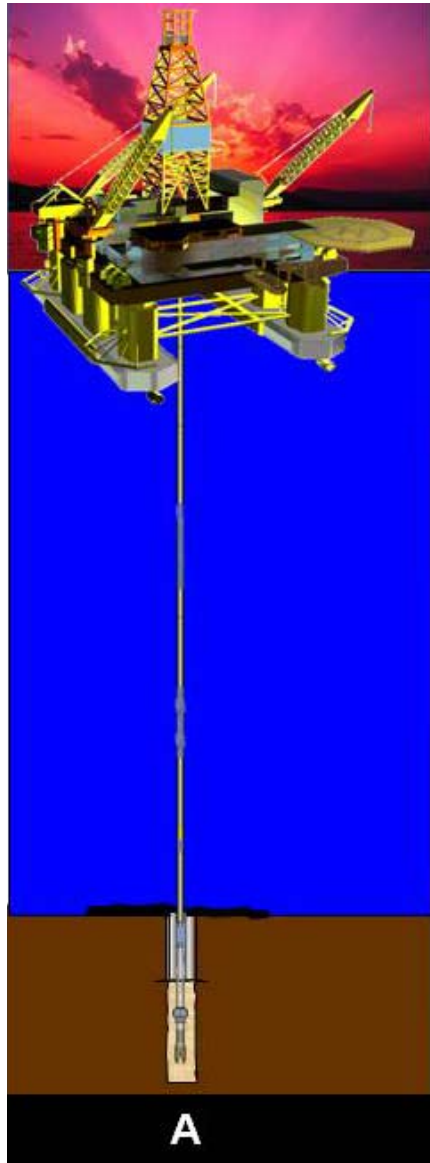

making tomorrow better



# Suction Module

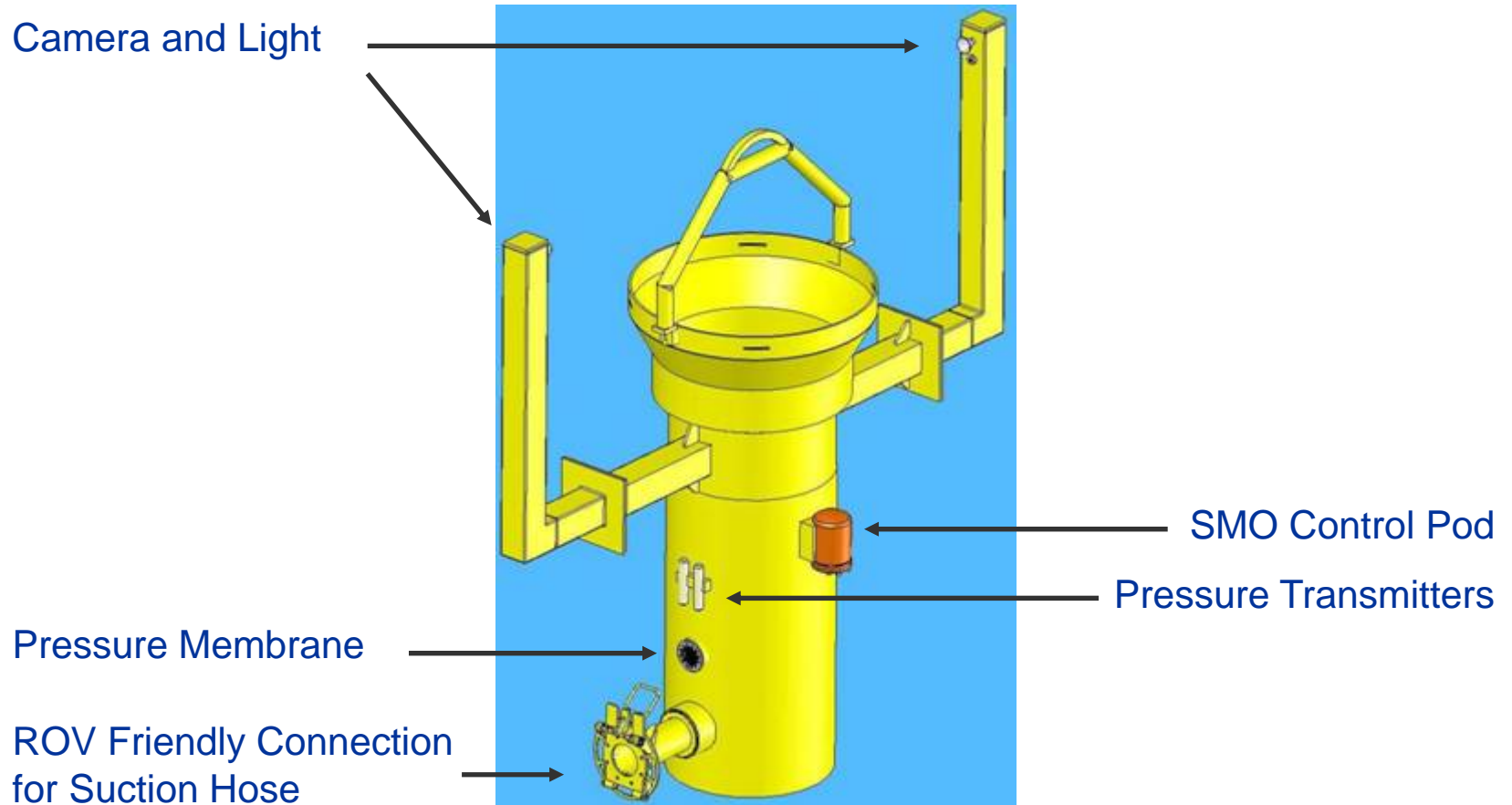

# AGR Pump Technology

- Similar to a centrifugal pump
- Utilize smooth discs in place of vaned impeller
- Pumps impart energy to fluid through viscous drag
- Very good for pumping viscous fluids
- Very good for Pumping solids
- Reliable for pumping abrasive slurries



# Single Gradient vs Dual Gradient

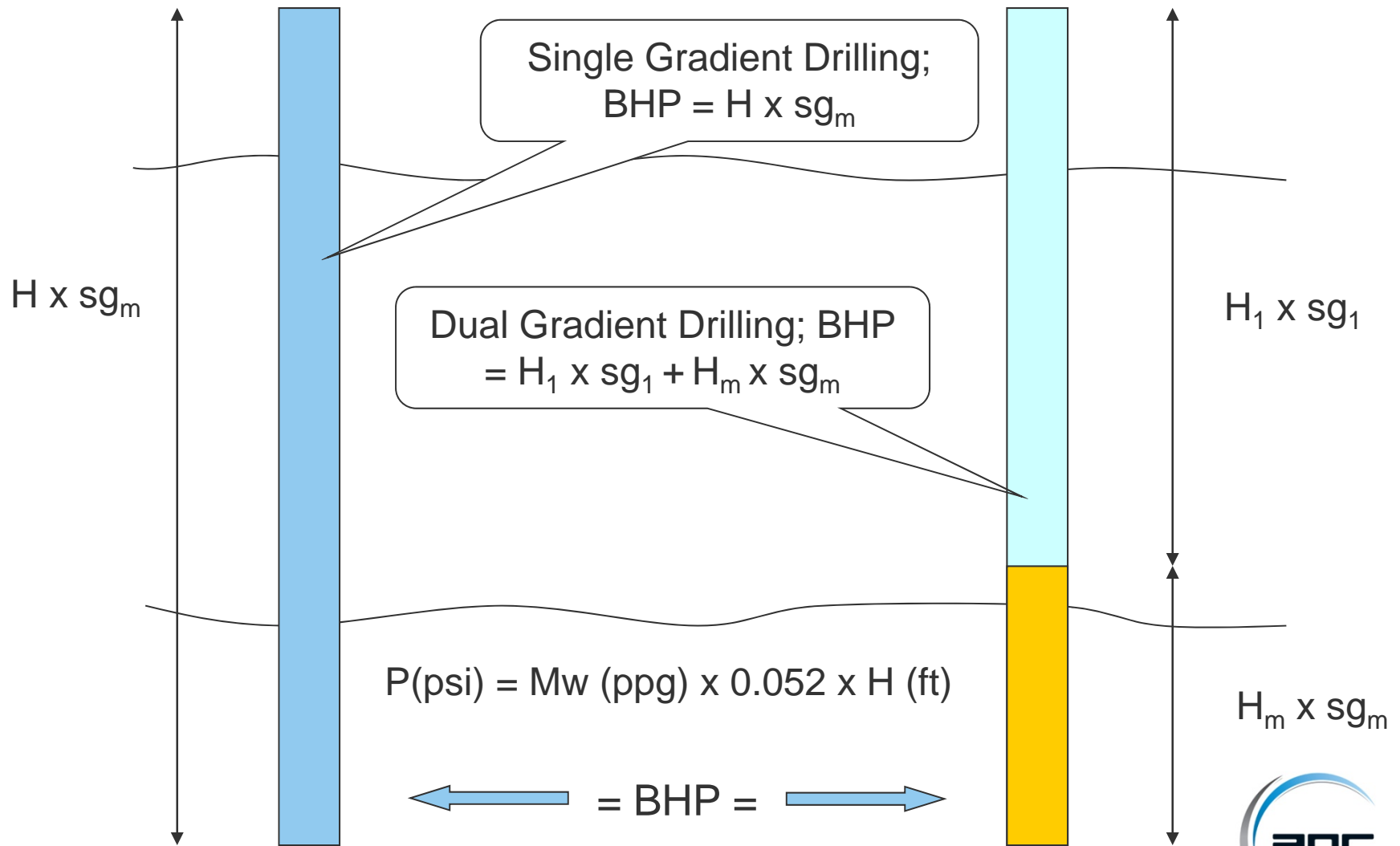

# Tophole is also Dual Gradient Drilling

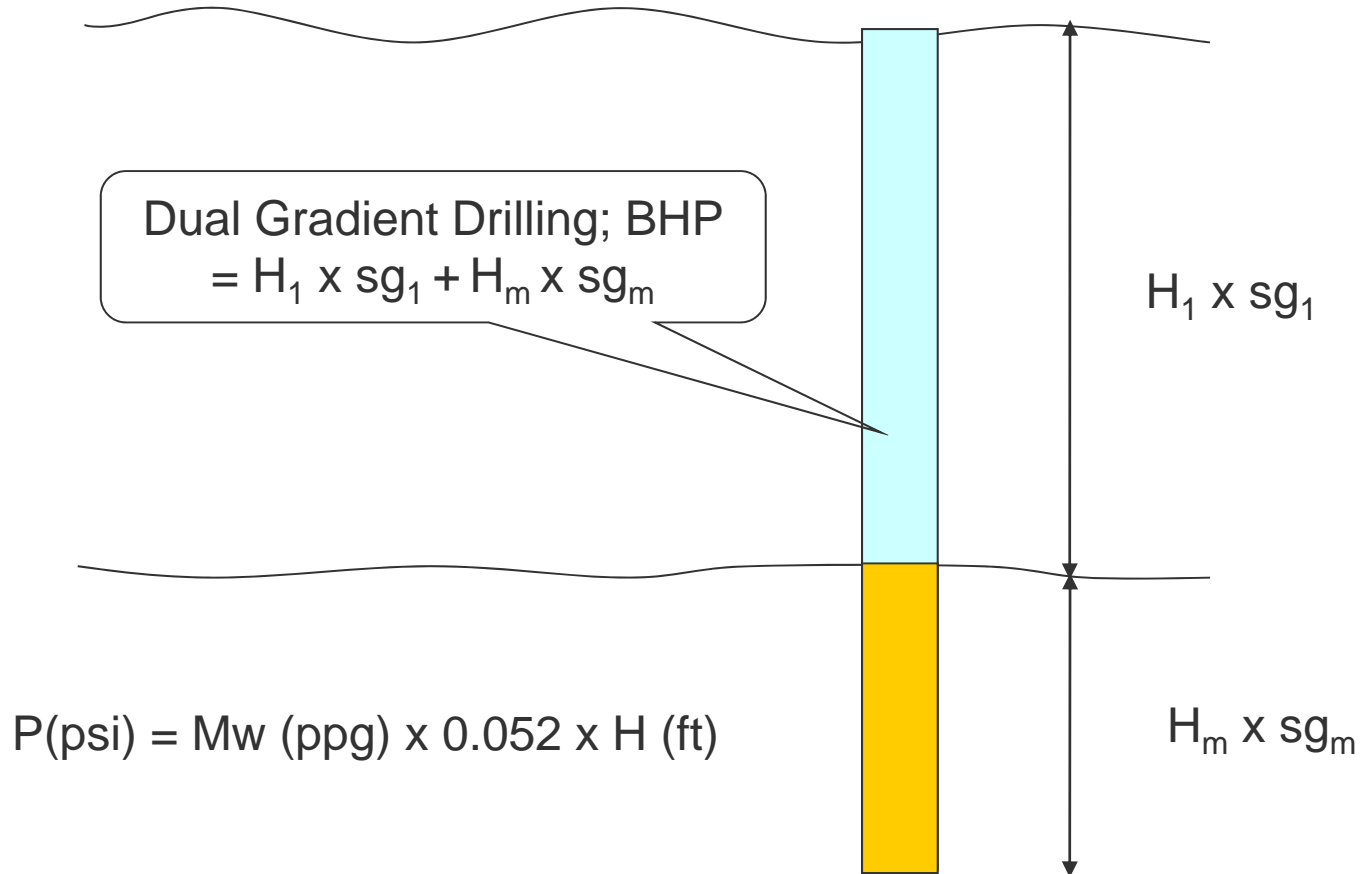

# RMR with Rotating Control Device (RCD)

## Benefits;

- Allows pressurized returns / MPD System
- Allows use of fluids that are incompatible with seawater
- Enables a back-pressure on the well to control a flow until mud weight has been increased
- Reduces risk of suction hose collapse



# AGR RCD on Eirik Raude



5 ½” to 8 ¼” OD tubular

Industry's first and only deployment  
of a subsea RCD to date



Size; 1.15m dia x 0.80m

Weight; 2.3 tons

# Going Deeper With RMR

---

making tomorrow better



# Deepwater RMR

Demo 2000 Project.  
Technology qualified for  
5000ft (1500m)

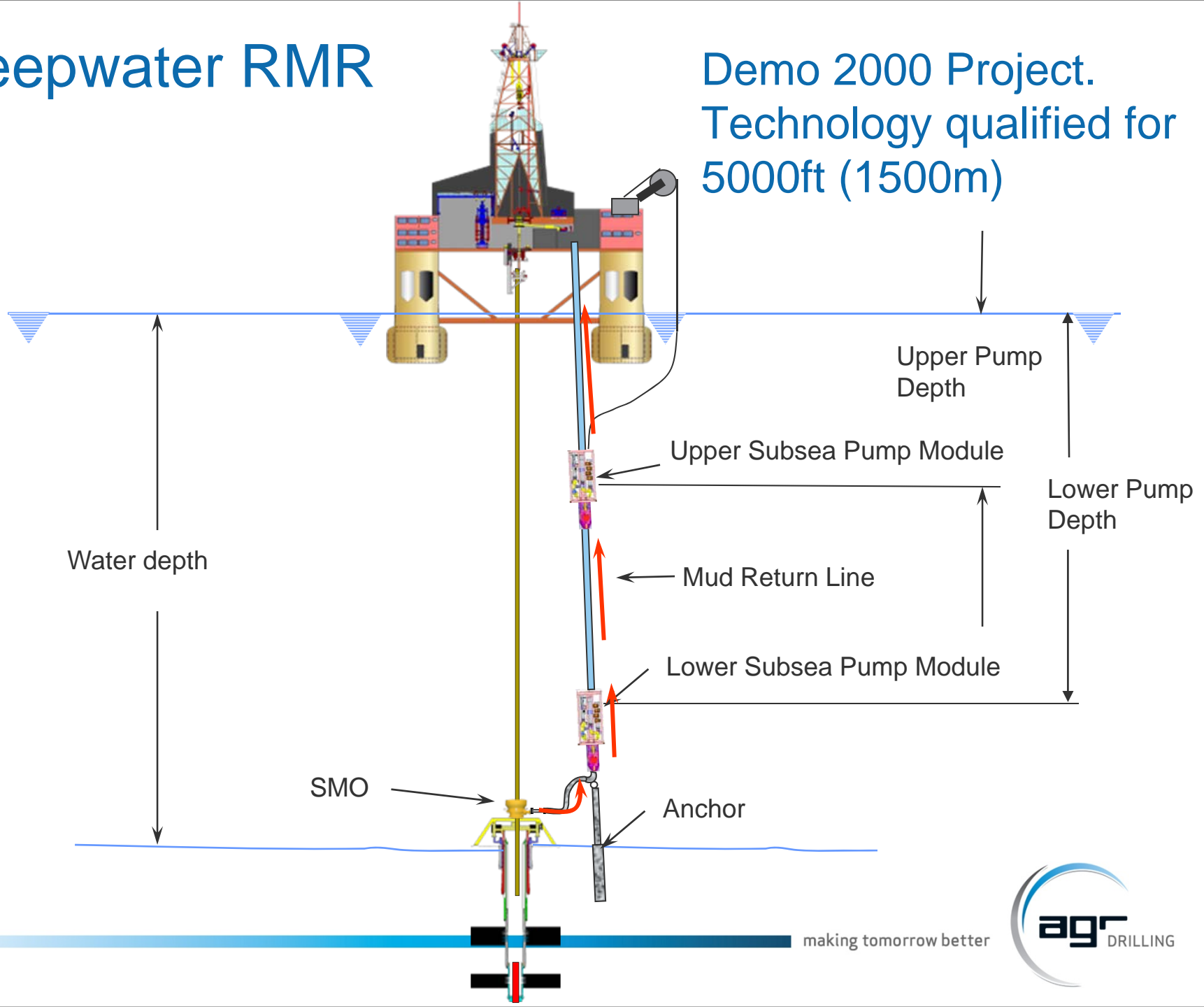



# Deep Water Pumps



making tomorrow better



# RDS System



# RDS – Riserless Drilling System

## Post BOP Riserless Drilling

- Riserless Drilling with a BOP and RCD
- Aim at eliminating Marine Drilling Riser
- Intermediate step may be riserless drilling through salt with a simple isolation device on seafloor
- Currently conduction Feasibility Study

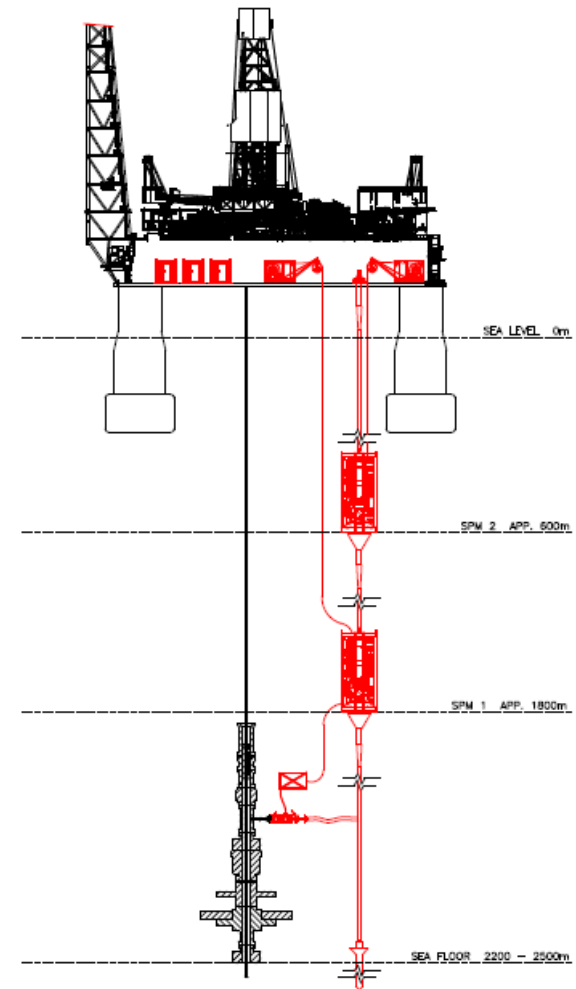

# Pump Technology

making tomorrow better



# Subsea RamPump

- Weatherford IP – licensed to AGR
- Positive displacement type of pump
- Energy transfer is accomplished with pressurized sea water
- Subsea efficiency more than 90% (Discpump 50%)
- Can be designed to API / full well control pressure rating
- One size (standardization) independent of water depth
  
- Study currently ongoing in Houston. Outside participation would be highly beneficial



# Subsea RamPump

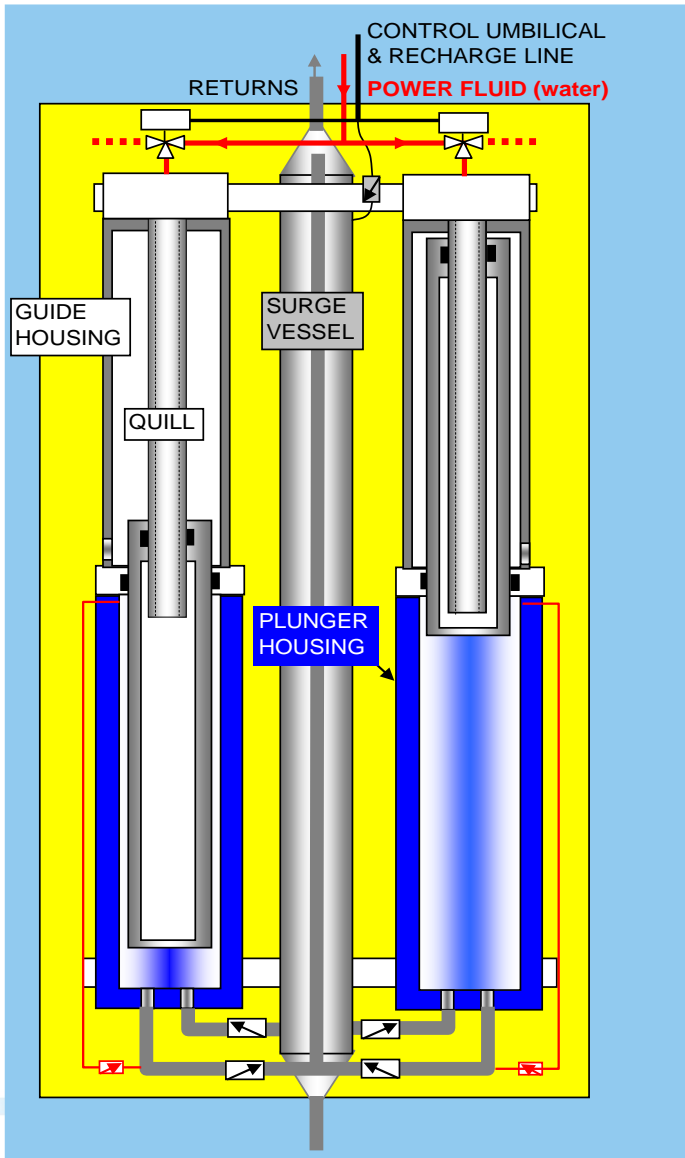

- Based on proven pump technology
- 1200 GPM, 12,000 psig, Approx. 5000 DP
- Dual 16" Plungers
- 120 inch Stroke, 3 CPM
- Check Valve Intakes
- Powered by sea water pumped from surface
- Surge Vessel to limit back pressure fluctuations
- Retrievable Module with Check and Control Valves

# Subsea RamPump vs Discpump

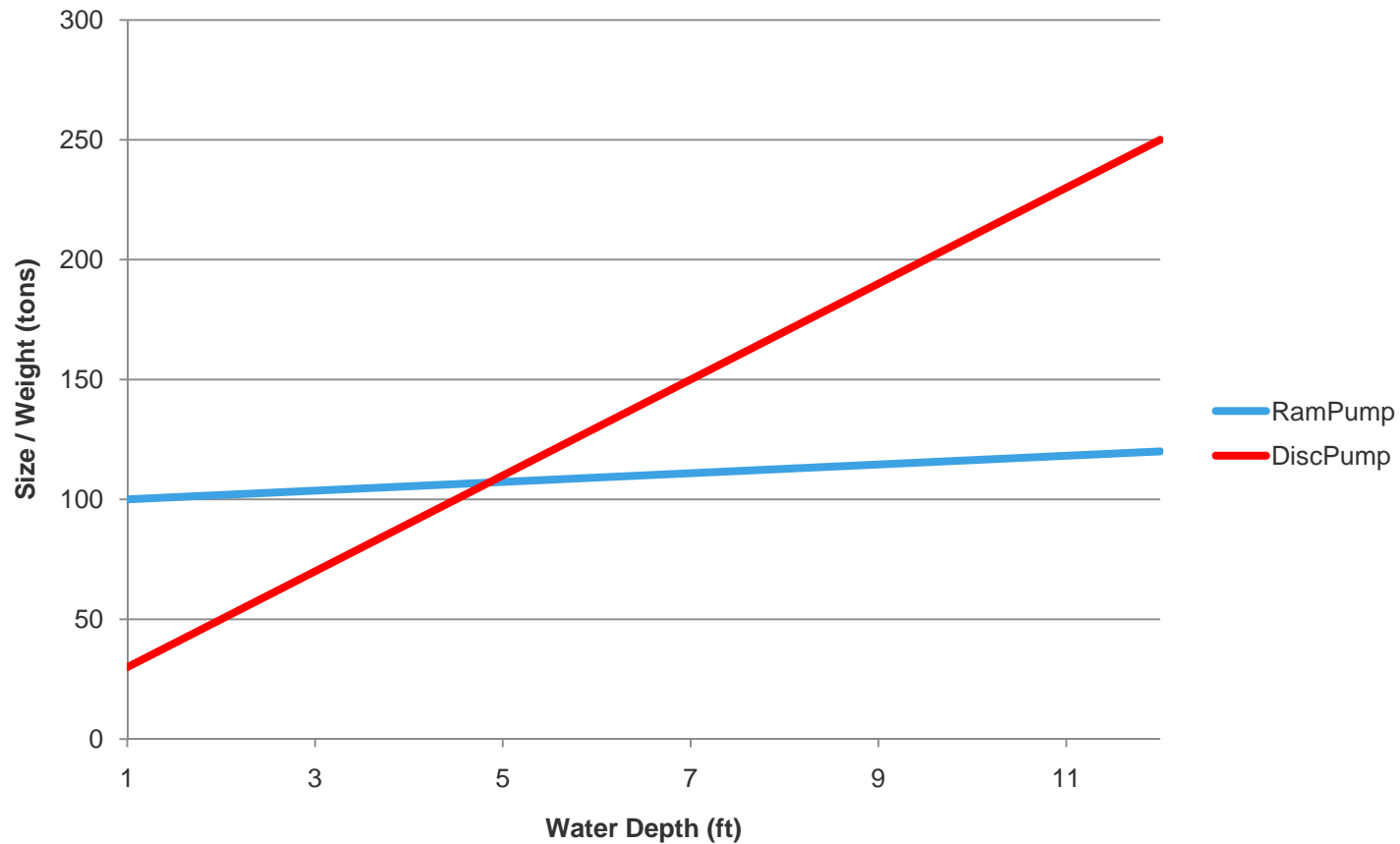

# Operating Parameters

- Hole size 26 in.
- Drilling rate 20 m/hr
- Flow rate 1200 gpm
- Mud Weight 10 ppg
- MRL size 6 in.
- Suction hose length 50 m
- Discharge hose 30 m
- RKB 20 m
- Mud Plastic Viscosity 15 cp
- Mud yield point 15
- Pump two 6 stage pumps

## Pump Power requirements for 6,000 ft to 20,000 ft

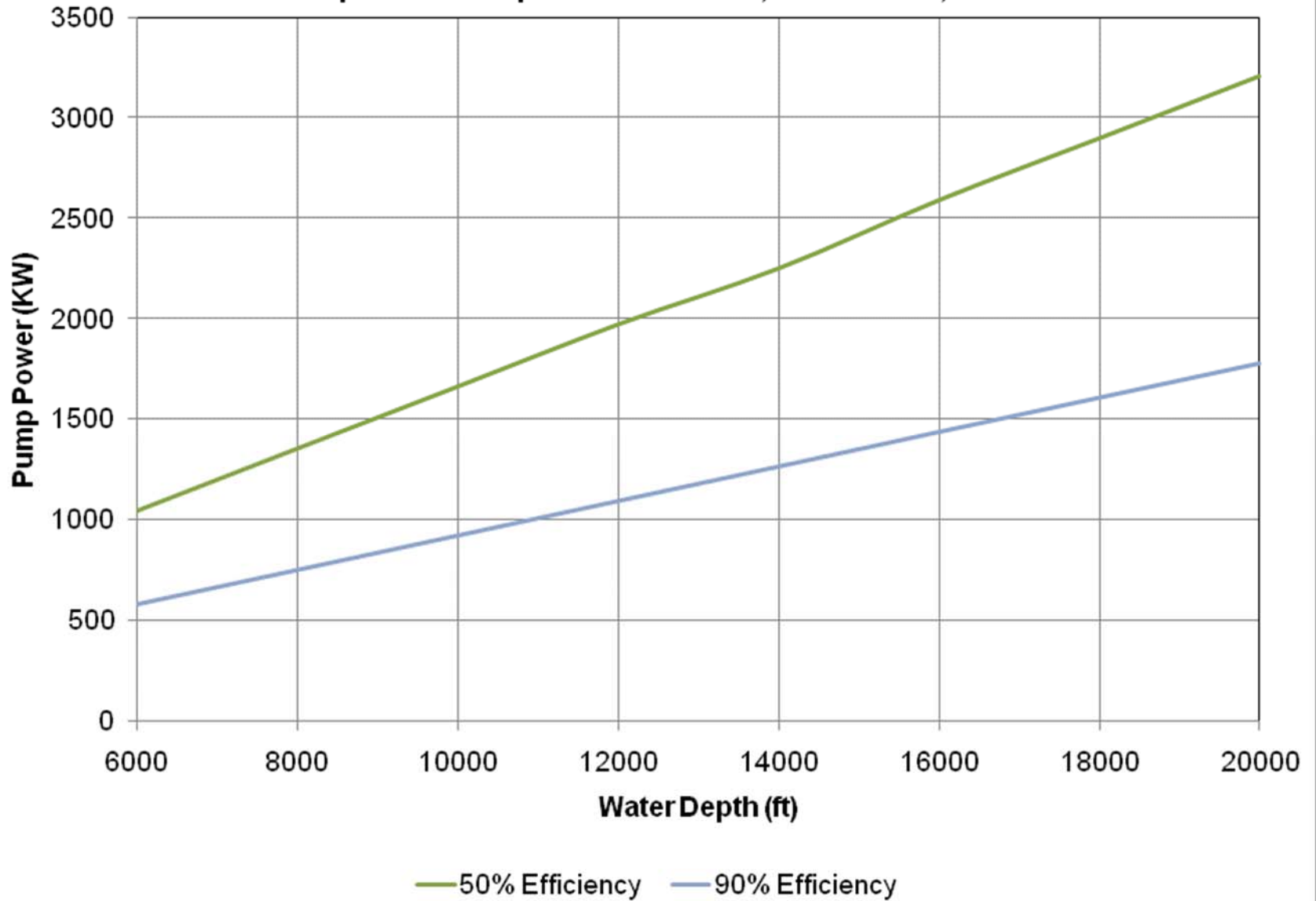

# The End

---

making tomorrow better

